



CLEATS, DUCT, AND WALL STACKS

ECCO
Manufactured
Products

CLEATS, DUCT, AND WALL STACKS

www.eccomfg.com

INDEX

BOOTS		ELBOWS (cont'd)	
Round to Oval Angle 90°	22	Short Way 90°	6
Round to Oval End 90°	22	Short Way 90° — 2" x 2" Throat	8
Round to Oval Straight	23	FILTER FRAMES	
BUTTON LOCK DUCT		Electronic Air Cleaner	19
6" — 30 Gauge	9	Electronic Air Cleaner (Honeywell)	19
7" — 30 Gauge	9	Electronic Air Cleaner (White Rodgers)	19
8" — 26 Gauge	11	Less Door	18
8" — 28 Gauge	10	With Door	19
8" — 30 Gauge	9	FIRE DAMPER ANGLE	21
10" — 26 Gauge	11	OVAL ELBOWS	
10" — 28 Gauge	10	Long Way 45°	23
10" — 30 Gauge	9	Long Way 90°	23
12" — 30 Gauge	10	Short Way 45°	23
14" — 30 Gauge	10	Short Way 90°	23
CLEAT FOLD DUCT		OVAL END CAP	22
8" — 26 Gauge	11	PLENUMS	
8" — 28 Gauge	11	Furnace	4
10" — 26 Gauge	12	Take Offs — 4" Rise	4
10" — 28 Gauge	12	Take Offs — Straight	4
CLEATS	20	Take Offs — Tapered 4" Rise	4
DUCT		RANGE HOOD TRANSITIONS (ADAPTERS)	21
Hanger Strap	21	RESIDENTIAL DUCT FITTINGS	24
End Caps	16	RETURN AIR	
Miscellaneous Sizes	12	Drop Kit	18
Rectangular — Commercial	13	Shoe	18
Rectangular — Commercial — Weight Chart	14 — 15	TAP-IN COLLARS	
Reducers	8	4" Long	17
Reducing Panels	9	4" x 10" Long	17
Return Air Drop	12	10" Long	17
ELBOWS		WALL STACKS	
Long Way 45°	5	Elbows	21
Long Way 45° — 2" x 2" Throat	6 — 7	End Caps	21
Long Way 90°	5	Oval	22
Long Way 90° — 2" x 2" Throat	7	Rectangular	21
Short Way 45°	6		
Short Way 45° — 2" x 2" Throat	7		

ECCO is proud to be a member of:



ASHRAE

American Society of
Heating, Refrigeration, and
Air Conditioning Engineers, Inc.
www.ashrae.com



HRAI

Heating, Refrigerating
and Air Conditioning
Institute of Canada
www.hrai.ca



HARDI

Heating, Airconditioning &
Refrigeration Distributors
International
www.hardinet.org



SMACNA

Sheet Metal & Air
Conditioning Contractors
National Association Inc.
www.smacna.org



SPIDA

Spiral Duct
Manufacturers
Association
www.spida.org



CLEATS, DUCT, AND WALL STACKS

ECCO
Manufactured
Products

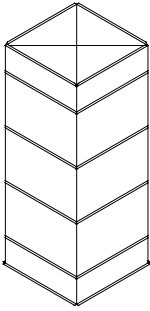

Plenum Take Off

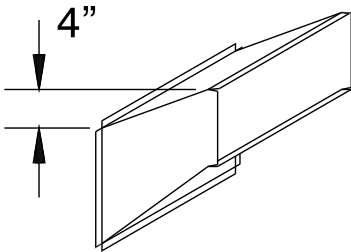

Plenum Take Off — 4" Rise

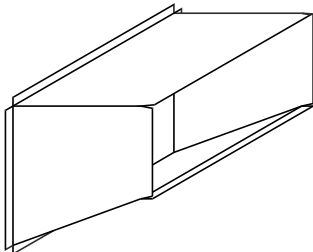

Plenum Take Off — Straight

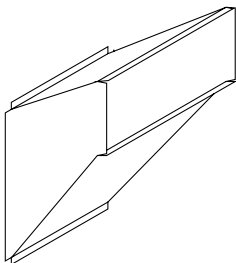

Plenum Take Off — Tapered

FURNACE PLENUMS

Please contact your ECCO sales representative for pricing.

PLENUM TAKE OFFS (*unassembled*) — 4" RISE

STOCK #	SIZE (")	CTN/QTY	WT/100	PRICE/EA
010885	8 × 8	10	340	\$ 41.71
011085	10 × 8	10	380	46.38
011285	12 × 8	10	410	48.56
011485	14 × 8	10	450	51.25
011685	16 × 8	10	480	59.52
011885	18 × 8	10	520	64.42
012085	20 × 8	10	550	73.30

Note: 2" Rise available upon request. Same price as 4" Rise.

PLENUM TAKE OFFS (*unassembled*) — STRAIGHT

STOCK #	SIZE (")	CTN/QTY	WT/100	PRICE/EA
010880	8 × 8	10	300	\$ 38.10
011080	10 × 8	10	330	39.86
011280	12 × 8	10	360	42.75
011480	14 × 8	10	390	45.09
011680	16 × 8	10	420	47.31
011880	18 × 8	10	450	50.65
012080	20 × 8	10	480	55.39

PLENUM TAKE OFFS — TAPERED 4" RISE

STOCK #	SIZE (")	CTN/QTY	WT/100	PRICE/EA
011487	14 × 8 to 12 × 14	10	430	\$ 64.36
011687	16 × 8 to 12 × 16	10	460	75.01
011887	18 × 8 to 12 × 18	10	500	84.78
012087	20 × 8 to 16 × 15	10	530	100.28
012287	22 × 8 to 17 × 15	10	540	110.49
012487	24 × 8 to 18 × 16	10	560	102.08

– E.&O.E. – May not be in stock at all branches, if so please allow 10 days for delivery. –
 – All Prices F.O.B. Our Warehouse – Subject to Change Without Notice – All Taxes Extra –



CLEATS, DUCT, AND WALL STACKS

ECCO
Manufactured
Products

DUCT ELBOWS LONG WAY 45° (unassembled)

STOCK #	SIZE (")	CTN/QTY	WT/100	PRICE/EA
022400	8 × 8	10	190	\$ 50.27
022500	10 × 8	10	240	53.68
022600	12 × 8	10	280	56.13
022700	14 × 8	10	330	65.89
022800	16 × 8	10	380	70.77
022900	18 × 8	10	490	78.09
023000	20 × 8	10	590	92.95
023100	22 × 8	10	690	102.13
023200	24 × 8	10	700	127.88
027212	12 × 10	10	294	65.89
027214	14 × 10	10	347	70.77
027216	16 × 10	10	399	78.09
027218	18 × 10	10	514	92.95
027220	20 × 10	10	620	102.13
027222	22 × 10	10	725	112.25
027224	24 × 10	–	830	129.40

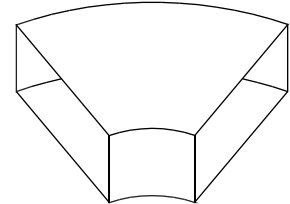

Duct Elbow Long Way 45°

DUCT ELBOWS LONG WAY 90° (unassembled)

STOCK #	SIZE (")	CTN/QTY	WT/100	PRICE/EA
020800	8 × 8	10	360	\$ 51.36
020900	10 × 8	10	420	63.45
021000	12 × 8	10	480	73.20
021100	14 × 8	10	550	85.41
021200	16 × 8	10	660	95.18
021300	18 × 8	5	780	104.93
021400	20 × 8	5	890	117.13
021500	22 × 8	–	1000	127.67
021600	24 × 8	–	110	161.02
027012	12 × 10	10	504	69.08
027014	14 × 10	10	578	77.30
027016	16 × 10	10	693	90.39
027018	18 × 10	5	819	108.91
027020	20 × 10	5	934	148.37
027022	22 × 10	–	1050	158.28
027024	24 × 10	–	1164	202.54

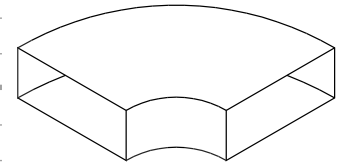

Duct Elbow Long Way 90°

– E.&O.E. – May not be in stock at all branches, if so please allow 10 days for delivery. –
 – All Prices F.O.B. Our Warehouse – Subject to Change Without Notice – All Taxes Extra –



CLEATS, DUCT, AND WALL STACKS

ECCO
Manufactured
Products

DUCT ELBOWS SHORT WAY 45° (unassembled)

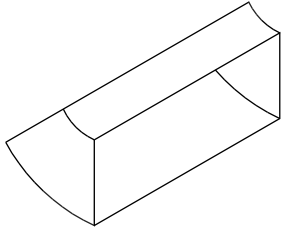

Duct Elbow Short Way 45°

STOCK #	SIZE (")	CTN/QTY	WT/100	PRICE/EA
025700	10 × 8	10	195	\$ 49.54
025800	12 × 8	10	200	53.68
025900	14 × 8	10	210	61.02
026000	16 × 8	10	220	68.32
026100	18 × 8	10	230	75.66
026200	20 × 8	10	250	85.41
026300	22 × 8	10	270	92.66
026400	24 × 8	10	310	106.25
027312	12 × 10	10	210	62.08
027314	14 × 10	10	221	67.23
027316	16 × 10	10	231	73.16
027318	18 × 10	10	242	77.79
027320	20 × 10	10	263	89.69
027322	22 × 10	10	284	100.84
027324	24 × 10	10	305	123.70

DUCT ELBOWS SHORT WAY 90° (unassembled)

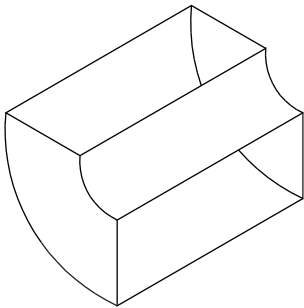

Duct Elbow Short Way 90°

STOCK #	SIZE (")	CTN/QTY	WT/100	PRICE/EA
024100	10 × 8	10	320	\$ 51.44
024200	12 × 8	10	350	57.34
024300	14 × 8	10	380	64.91
024400	16 × 8	10	410	73.20
024500	18 × 8	10	450	82.97
024600	20 × 8	10	500	92.73
024700	22 × 8	10	550	102.56
024800	24 × 8	10	620	113.33
027120	20 × 10	10	540	132.84
027124	24 × 10	10	660	169.47

DUCT ELBOWS LONG WAY 45° — 2 × 2 THROAT

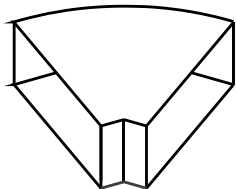

Duct Elbow Long Way 45° —
2 × 2 Throat

STOCK #	SIZE (")	CTN/QTY	WT/100	PRICE/EA
022410	8 × 8	10	170	\$ 31.66
022510	10 × 8	10	220	34.72
022610	12 × 8	10	260	37.66
022710	14 × 8	10	310	40.69
022810	16 × 8	10	360	43.74
022910	18 × 8	10	470	46.76

(cont'd on next page)

– E.&O.E. – May not be in stock at all branches, if so please allow 10 days for delivery. –
– All Prices F.O.B. Our Warehouse – Subject to Change Without Notice – All Taxes Extra –



CLEATS, DUCT, AND WALL STACKS

ECCO
Manufactured
Products

DUCT ELBOWS LONG WAY 45° — 2 × 2 THROAT (cont'd)

STOCK #	SIZE (")	CTN/QTY	WT/100	PRICE/EA
023010	20 × 8	–	570	\$ 50.30
023110	22 × 8	–	670	59.33
023210	24 × 8	–	800	69.80
023310	26 × 8	–	910	80.41
023410	28 × 8	–	1000	92.95
023510	30 × 8	–	1100	110.60
027234	24 × 10	–	910	83.12

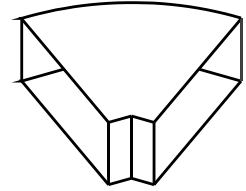

Duct Elbow Long Way 45° —
2 × 2 Throat

DUCT ELBOWS SHORT WAY 45° — 2 × 2 THROAT

STOCK #	SIZE (")	CTN/QTY	WT/100	PRICE/EA
025710	10 × 8	10	175	\$ 30.20
025810	12 × 8	10	180	32.17
025910	14 × 8	10	190	34.23
026010	16 × 8	10	200	36.19
026110	18 × 8	10	210	38.24
026210	20 × 8	10	230	42.75
026310	22 × 8	10	250	50.30
026410	24 × 8	10	270	57.76
026510	26 × 8	10	290	65.30
026610	28 × 8	10	320	75.42
026710	30 × 8	10	350	90.50

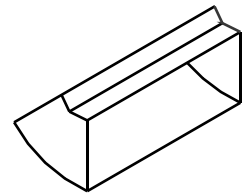

Duct Elbow Short Way 45° —
2 × 2 Throat

DUCT ELBOWS LONG WAY 90° — 2 × 2 THROAT

STOCK #	SIZE (")	CTN/QTY	WT/100	PRICE/EA
020810	8 × 8	10	320	\$ 39.71
020910	10 × 8	10	380	41.71
021010	12 × 8	10	440	44.23
021110	14 × 8	10	510	48.24
021210	16 × 8	10	620	54.77
021310	18 × 8	5	740	64.82
021410	20 × 8	5	850	78.46
021510	22 × 8	5	960	92.45
021610	24 × 8	5	1090	108.54
021710	26 × 8	5	1240	125.61
021810	28 × 8	5	1410	144.74
021910	30 × 8	5	1650	170.91
027034	24 × 10	5	1240	125.62

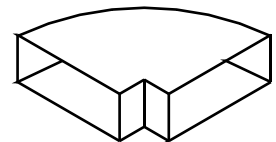

Duct Elbow Long Way 90° —
2 × 2 Throat

– E.&O.E. – May not be in stock at all branches, if so please allow 10 days for delivery. –
– All Prices F.O.B. Our Warehouse – Subject to Change Without Notice – All Taxes Extra –



CLEATS, DUCT, AND WALL STACKS

ECCO
Manufactured
Products

DUCT ELBOWS SHORT WAY 90° — 2 × 2 THROAT

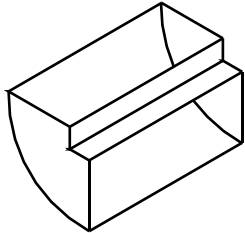

Duct Elbow Short Way 90° —
2 × 2 Throat

STOCK #	SIZE (")	CTN/QTY	WT/100	PRICE/EA
024110	10 × 8	10	280	\$ 37.66
024210	12 × 8	10	310	42.26
024310	14 × 8	10	340	46.76
024410	16 × 8	10	370	51.27
024510	18 × 8	10	410	60.32
024610	20 × 8	10	460	64.82
024710	22 × 8	10	510	75.91
024810	24 × 8	10	560	89.43
024910	26 × 8	10	610	103.07
025010	28 × 8	10	660	118.66
025110	30 × 8	10	720	140.71
027113	12 × 10	10	325	59.61
027115	14 × 10	10	357	66.62
027117	16 × 10	10	389	78.13
027119	18 × 10	10	431	92.93
027123	22 × 10	–	536	117.15
027134	24 × 10	–	594	130.93

DUCT REDUCERS (unassembled)

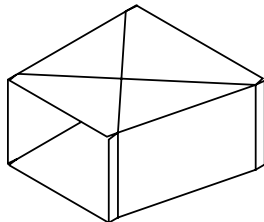

Duct Reducer

STOCK #	SIZE (")	CTN/QTY	WT/100	PRICE/EA
032460	28 × 8 – 20 × 8	10	480	\$ 61.93
032470	24 × 8 – 20 × 8	10	450	74.82
032480	20 × 8 – 18 × 8	10	370	69.47
032482	20 × 8 – 16 × 8	10	370	64.12
032484	20 × 8 – 14 × 8	10	405	58.78
032486	20 × 8 – 12 × 8	10	360	53.43
032500	18 × 8 – 16 × 8	10	350	55.88
032600	18 × 8 – 14 × 8	10	330	51.20
032700	18 × 8 – 12 × 8	10	320	46.53
032800	16 × 8 – 14 × 8	10	310	49.77
032900	16 × 8 – 12 × 8	10	300	45.23
033000	16 × 8 – 10 × 8	10	290	40.71
033100	14 × 8 – 12 × 8	10	280	44.90
033200	14 × 8 – 10 × 8	10	270	40.41
033300	14 × 8 – 8 × 8	10	265	35.92
033400	12 × 8 – 10 × 8	10	260	40.25
033500	12 × 8 – 8 × 8	10	250	35.78
033600	10 × 8 – 8 × 8	10	240	35.15

– E.&O.E. – May not be in stock at all branches, if so please allow 10 days for delivery. –
– All Prices F.O.B. Our Warehouse – Subject to Change Without Notice – All Taxes Extra –



CLEATS, DUCT, AND WALL STACKS

ECCO
Manufactured
Products

DUCT REDUCING PANELS

STOCK #	DESCRIPTION	CTN/QTY	WT/100	PRICE/EA
034002	2" Reducing Panel – 8" Duct	20	60	\$ 11.33
034004	4" Reducing Panel – 8" Duct	20	80	13.32
034003	2" Reducing Panel – 10" Duct	20	149	16.37
034005	4" Reducing Panel – 10" Duct	20	164	17.62

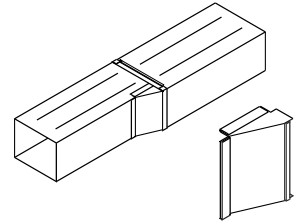

Duct Reducing Panel

BUTTON LOCK DUCT 6" — 30 GAUGE

STOCK #	SIZE (")	LENGTH/FT	FT/BDL	WT/100 FT	PRICE/FT
029130	14 × 6	8	80	226	\$ 12.46
029430	20 × 6	8	80	290	17.97

BUTTON LOCK DUCT 7" — 30 GAUGE

STOCK #	SIZE (")	LENGTH/FT	FT/BDL	WT/100 FT	PRICE/FT
030230	10 × 7	8	160	195	\$ 13.06
040330	12 × 7	5	50	216	14.63
030330	12 × 7	8	160	216	14.63
040430	14 × 7	5	50	237	15.54
030430	14 × 7	8	160	237	15.54

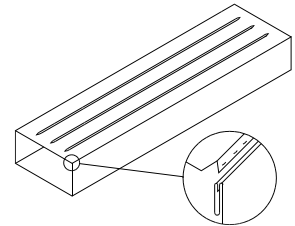

Button Lock Duct

BUTTON LOCK DUCT 8" — 30 GAUGE

STOCK #	SIZE (")	LENGTH/FT	FT/BDL	WT/100 FT	PRICE/FT
040830	8 × 8	5	50	185	\$ 11.33
030830	8 × 8	8	160	185	11.33
040930	10 × 8	5	50	206	12.33
030930	10 × 8	8	160	206	12.33
041030	12 × 8	5	50	226	12.41
031030	12 × 8	8	160	226	12.41
041130	14 × 8	5	50	247	14.11
031130	14 × 8	8	160	247	14.11

BUTTON LOCK DUCT 10" — 30 GAUGE

STOCK #	SIZE (")	LENGTH/FT	FT/BDL	WT/100 FT	PRICE/FT
041230	10 × 10	5	50	226	\$ 14.63
041830	12 × 10	5	50	247	15.28
031830	12 × 10	8	160	247	15.28
041930	14 × 10	5	50	268	18.14
031930	14 × 10	8	160	268	18.14

Note: For Wall Stack Duct and Fittings see page 21 – 23.

– E.&O.E. – May not be in stock at all branches, if so please allow 10 days for delivery. –
 – All Prices F.O.B. Our Warehouse – Subject to Change Without Notice – All Taxes Extra –



CLEATS, DUCT, AND WALL STACKS

ECCO
Manufactured
Products

BUTTON LOCK DUCT 12" — 30 GAUGE

STOCK #	SIZE (")	LENGTH/FT	FT/BDL	WT/100 FT	PRICE/FT
102740	2-1/4 × 12	5	75	167	\$ 12.33
102758	3-1/4 × 12	8	120	177	14.32

BUTTON LOCK DUCT 14" — 30 GAUGE

STOCK #	SIZE (")	LENGTH/FT	FT/BDL	WT/100 FT	PRICE/FT
102765	3-1/4 × 14	5	75	198	\$ 18.27
102768	3-1/4 × 14	8	120	198	18.27

BUTTON LOCK DUCT 8" — 28 GAUGE

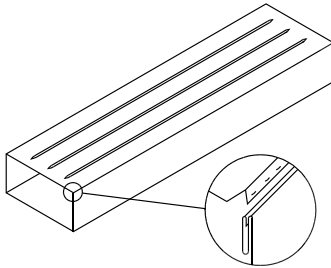

Button Lock Duct

STOCK #	SIZE (")	LENGTH/FT	FT/BDL	WT/100 FT	PRICE/FT
030828	8 × 8	8	160	236	\$ 12.72
030928	10 × 8	8	160	264	13.84
031028	12 × 8	8	160	290	15.32
041128	14 × 8	5	50	294	17.53
031128	14 × 8	8	160	294	17.53
041228	16 × 8	5	50	319	17.75
031228	16 × 8	8	160	319	17.75
041328	18 × 8	5	50	344	20.57
031328	18 × 8	8	160	344	20.57
041428	20 × 8	5	50	368	21.40
031428	20 × 8	8	160	368	21.40

BUTTON LOCK DUCT 10" — 28 GAUGE

STOCK #	SIZE (")	LENGTH/FT	FT/BDL	WT/100 FT	PRICE/FT
041828	12 × 10	5	50	310	\$ 18.58
031828	12 × 10	8	160	310	18.58
041928	14 × 10	5	50	319	19.01
031928	14 × 10	8	160	319	19.01
042028	16 × 10	5	50	344	20.44
032028	16 × 10	8	160	344	20.44
042128	18 × 10	5	50	368	21.57
032128	18 × 10	8	160	368	21.57

- E.&O.E. - May not be in stock at all branches, if so please allow 10 days for delivery. -
 - All Prices F.O.B. Our Warehouse - Subject to Change Without Notice - All Taxes Extra -



CLEATS, DUCT, AND WALL STACKS

ECCO
Manufactured
Products

BUTTON LOCK DUCT 8" — 26 GAUGE

STOCK #	SIZE (")	LENGTH/FT	FT/BDL	WT/100 FT	PRICE/FT
041426	20 × 8	5	50	427	\$ 24.78
031426	20 × 8	8	160	427	24.78
041526	22 × 8	5	50	456	25.87
031526	22 × 8	8	160	456	25.87
041626	24 × 8	5	50	485	27.69
031626	24 × 8	8	160	485	27.69
041726	25 × 8	5	50	499	29.43

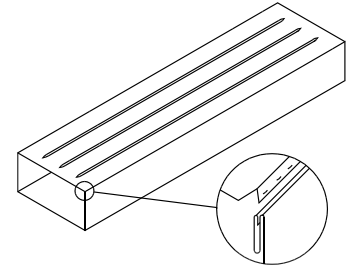

Button Lock Duct

BUTTON LOCK DUCT 10" — 26 GAUGE

STOCK #	SIZE (")	LENGTH/FT	FT/BDL	WT/100 FT	PRICE/FT
042226	20 × 10	5	50	456	\$ 26.73
032226	20 × 10	8	160	456	26.73
042326	22 × 10	5	50	485	29.38
032326	22 × 10	8	160	485	29.38
042426	24 × 10	5	50	513	30.55
032426	24 × 10	8	160	513	30.55

CLEAT FOLD DUCT 8" — 28 GAUGE

STOCK #	SIZE (")	LENGTH/FT	FT/BDL	WT/100 FT	PRICE/FT
588808	8 × 8	5	—	232	\$ 13.32
588810	10 × 8	5	—	258	13.76
588812	12 × 8	5	—	284	15.10
588814	14 × 8	5	—	310	16.36
588816	16 × 8	5	—	336	17.97
588818	18 × 8	5	—	362	19.53
588820	20 × 8	5	—	388	21.87

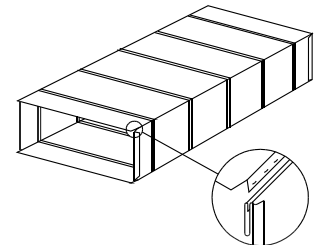

Cleat Fold Duct

CLEAT FOLD DUCT 8" — 26 GAUGE

STOCK #	SIZE (")	LENGTH/FT	FT/BDL	WT/100 FT	PRICE/FT
568822	22 × 8	5	—	480	\$ 27.82
568824	24 × 8	5	—	511	29.16
568828	28 × 8	5	—	571	31.03
568830	30 × 8	5	—	601	32.55

– E.&O.E. – May not be in stock at all branches, if so please allow 10 days for delivery. –
 – All Prices F.O.B. Our Warehouse – Subject to Change Without Notice – All Taxes Extra –



CLEATS, DUCT, AND WALL STACKS

ECCO
Manufactured
Products

CLEAT FOLD DUCT 10" — 28 GAUGE

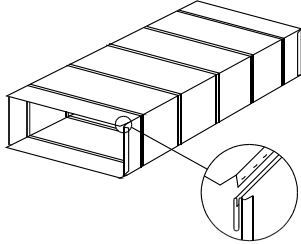

Cleat Fold Duct

STOCK #	SIZE (")	LENGTH/FT	FT/BDL	WT/100 FT	PRICE/FT
589010	10 × 10	5	–	284	\$ 15.71
589012	12 × 10	5	–	310	17.01
589014	14 × 10	5	–	336	18.31
589016	16 × 10	5	–	362	20.35
589018	18 × 10	5	–	388	21.66

CLEAT FOLD DUCT 10" — 26 GAUGE

STOCK #	SIZE (")	LENGTH/FT	FT/BDL	WT/100 FT	PRICE/FT
569020	20 × 10	5	–	480	\$ 27.56
569022	22 × 10	5	–	511	28.82
569024	24 × 10	5	–	541	29.43
569026	26 × 10	5	–	570	30.01
569030	30 × 10	5	–	631	37.27

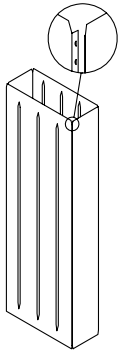

Return Air Drop Duct

RETURN AIR DROP DUCT

STOCK #	SIZE (")	GA	LENGTH (")	WT/100	PRICE/EA
042526	25 × 8	26	76	3157	\$ 186.84
042926	24 × 8	26	84	3388	202.20
042726	24 × 10	26	76	3248	186.84
042928	25 × 9-1/2	26	96	4120	210.49

MISCELLANEOUS DUCT SIZES

STOCK #	SIZE (")	GA	LENGTH	PRICE
042450	24 × 8	26	48"	\$ 27.69/ft
041826	25 × 9-1/2	26	5 ft	23.36/ft
042466	25 × 9-1/2	26	48"	23.36/ft
031726	25 × 9-1/2	26	8 ft	23.36/ft
042430	25 × 12	26	5 ft	28.77/ft
042440	26 × 9	26	40"	84.37/length
042448	26 × 9	26	48"	25.30/ft
569124	24 × 12	26	5 ft	30.01/ft
	Cleat Fold Commercial Duct			

– E.&O.E. – May not be in stock at all branches, if so please allow 10 days for delivery. –
– All Prices F.O.B. Our Warehouse – Subject to Change Without Notice – All Taxes Extra –



CLEATS, DUCT, AND WALL STACKS

ECCO
Manufactured
Products

RECTANGULAR DUCT (unassembled) — SMACNA APPROVED

STOCK #	GAUGE	1" LINACOUSTIC INSULATION	PRICE/FT
500028	28		P.O.A.
500026	26		P.O.A.
500024	24	P.O.A. PER SQUARE FOOT	P.O.A.
500022	22	INSTALLED	P.O.A.
500020	20		P.O.A.
500018	18		P.O.A.

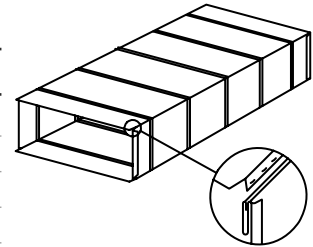

Rectangular Duct

OPTIONS:

- Duct sizes available in 5 ft. or 4 ft. lengths.
- Button Punch Snap Lock: 28 gauge through 20 gauge or Pittsburgh Lock: 28 gauge through 18 gauge.
- 18 gauge available with Pittsburgh Lock only (4 ft. lengths).
- Drive Cleat fold turned on ends.
- Also available with Straight Ends No Notches for Ductmate type of connector.
- Reinforcing Bead as per SMACNA.
- With or without Block Ends.

PLEASE SPECIFY WHEN ORDERING:

1. Duct size × length (5 ft. or 4 ft.).
2. Gauge.
3. Type of Lock: Button Punch Snaplock or Pittsburgh Lock.
4. Drive fold turned on ends for slip and drive or no notches straight ends for applying secondary flanges.
5. For insulated duct, add 2" to duct size, e.g.: 20" × 10" = 22" × 12" duct size, to allow for 1" insulation thickness.

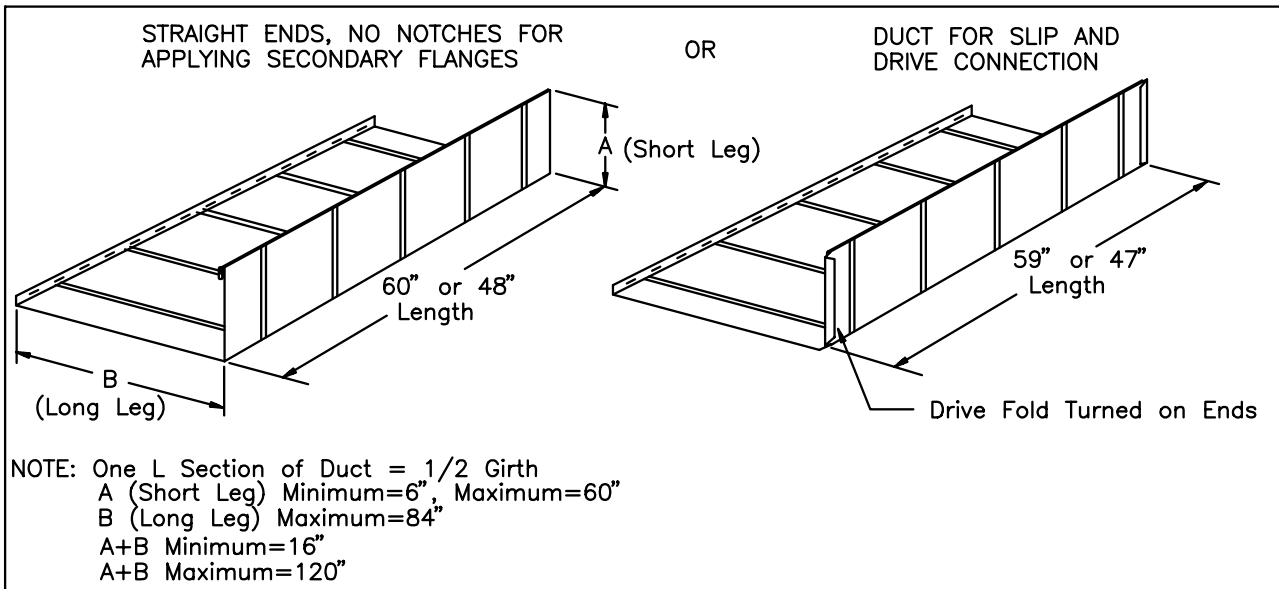

- E.&O.E. - May not be in stock at all branches, if so please allow 10 days for delivery. -
 - All Prices F.O.B. Our Warehouse - Subject to Change Without Notice - All Taxes Extra -



CLEATS, DUCT, AND WALL STACKS

RECTANGULAR DUCT WEIGHT CHART INSTRUCTIONS

1. Find weight for duct size: 20" × 10" — 24 gauge. 20" + 10" = 30" therefore under "DUCT SIZE" column (1/2 of Girth) = 30. Under 24 gauge column weight = 6.13 lbs/ft.
2. Find duct liner requirement per foot of 20" × 10" duct. 20" + 10" = 30" therefore under "DUCT SIZE" column (1/2 of Girth) = 30. Under "SURFACE AREA NO. OF SQ.FT. PER LINEAR FOOT" column = 5.00 sq.ft. per Linear Foot of Duct.

Note: Actual inside dimensions of duct after 1" Linacoustic Insulation is installed = 8" × 8", therefore care must be taken to size duct accordingly.

RECTANGULAR DUCT WEIGHT CHART (unassembled)

DUCT SIZE (1/2 OF GIRTH)	SURFACE AREA NO. OF SQ.FT. PER LINEAR FT.	WEIGHT — LBS PER LINEAR FOOT OF DUCT					
		28GA	26GA	24GA	22GA	20GA	18GA
16	2.67	2.32	2.69	3.43	4.17	4.92	6.40
18	3.00	2.58	2.99	3.82	4.64	5.47	7.12
20	3.33	2.84	3.29	4.20	5.11	6.02	7.84
22	3.67	3.10	3.60	4.59	5.58	6.57	8.56
24	4.00	3.36	3.90	4.97	6.05	7.12	9.27
26	4.33	3.62	4.20	5.36	6.52	7.68	9.99
28	4.67	3.88	4.50	5.74	6.99	8.23	10.71
30	5.00	4.14	4.80	6.13	7.45	8.78	11.43
32	5.33	4.40	5.11	6.51	7.92	9.33	12.15
34	5.67	4.66	5.41	6.90	8.39	9.88	12.87
36	6.00	4.92	5.71	7.29	8.86	10.44	13.59
38	6.33	5.18	6.01	7.67	9.33	10.99	14.30
40	6.67	5.44	6.31	8.06	9.80	11.54	15.02
42	7.00	5.70	6.62	8.44	10.27	12.09	15.74
44	7.33	5.96	6.92	8.83	10.74	12.64	16.46
46	7.67	6.22	7.22	9.21	11.20	13.20	17.18
48	8.00	6.48	7.52	9.60	11.67	13.75	17.90
50	8.33	6.74	7.82	9.98	12.14	14.30	18.62
52	8.67	7.01	8.13	10.37	12.61	14.85	19.33
54	9.00	7.27	8.43	10.75	13.08	15.40	20.05
56	9.33	7.53	8.73	11.14	13.55	15.96	20.77
58	9.67	7.79	9.03	11.52	14.02	16.51	21.49
60	10.00	8.05	9.33	11.91	14.48	17.06	22.21
62	10.33	8.31	9.64	12.29	14.95	17.61	22.93
64	10.67	8.57	9.94	12.68	15.42	18.16	23.65

(cont'd on next page)

– E.&O.E. – May not be in stock at all branches, if so please allow 10 days for delivery. –
 – All Prices F.O.B. Our Warehouse – Subject to Change Without Notice – All Taxes Extra –



CLEATS, DUCT, AND WALL STACKS

ECCO
Manufactured
Products

RECTANGULAR DUCT WEIGHT CHART *(unassembled) (cont'd)*

DUCT SIZE (1/2 OF GIRTH)	SURFACE AREA NO. OF SQ.FT. PER LINEAR FT.	WEIGHT — LBS PER LINEAR FOOT OF DUCT					
		28GA	26GA	24GA	22GA	20GA	18GA
66	11.00	8.83	10.24	13.07	15.89	18.72	24.36
68	11.33	9.09	10.54	13.45	16.36	19.27	25.08
70	11.67	9.35	10.84	13.84	16.83	19.82	25.80
72	12.00	9.61	11.15	14.22	17.30	20.37	26.52
74	12.33	9.87	11.45	14.61	17.77	20.92	27.24
76	12.67	10.13	11.75	14.99	18.23	21.48	27.96
78	13.00	10.39	12.05	15.38	18.70	22.03	28.68
80	13.33	10.65	12.35	15.76	19.17	22.58	29.39
82	13.67	10.91	12.66	16.15	19.64	23.13	30.11
84	14.00	11.17	12.96	16.53	20.11	23.68	30.83
86	14.33	11.43	13.26	16.92	20.58	24.24	31.55
88	14.67	11.69	13.56	17.30	21.05	24.79	32.27
90	15.00	11.95	13.86	17.69	21.51	25.34	32.99
92	15.33	12.21	14.17	18.08	21.98	25.89	33.70
94	15.67	12.47	14.47	18.46	22.45	26.44	34.42
96	16.00	12.73	14.77	18.85	22.92	27.00	35.14
98	16.33	12.99	15.07	19.23	23.39	27.55	35.86
100	16.67	13.25	15.37	19.62	23.86	28.10	36.58
102	17.00	13.51	15.68	20.00	24.33	28.65	37.30
104	17.33	13.77	15.98	20.39	24.80	29.20	38.02
106	17.67	14.03	16.28	20.77	25.26	29.76	38.73
108	18.00	14.29	16.58	21.16	25.73	30.31	39.45
110	18.33	14.56	16.88	21.54	26.20	30.86	40.17
112	18.67	14.82	17.19	21.93	26.67	31.41	40.89
114	19.00	15.08	17.49	22.31	27.14	31.96	41.61
116	19.33	15.34	17.79	22.70	27.61	32.52	42.33
118	19.67	15.60	18.00	23.08	28.08	33.07	43.05
120	20.00	15.86	18.39	23.47	28.55	33.62	43.76

– E.&O.E. – May not be in stock at all branches, if so please allow 10 days for delivery. –
 – All Prices F.O.B. Our Warehouse – Subject to Change Without Notice – All Taxes Extra –



CLEATS, DUCT, AND WALL STACKS

ECCO
Manufactured
Products

DUCT END CAPS

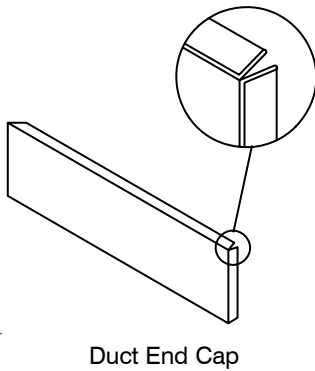

STOCK #	SIZE (")	PCS/BDL	WT/100	PRICE/EA
103000	2-1/4 × 12	10	23	\$ 6.62
103100	3-1/4 × 10	10	21	5.37
103102	3-1/4 × 12	10	25	8.78
043500	8 × 8	10	34	6.00
043600	10 × 8	10	42	6.81
044450	10 × 10	10	62	8.06
043700	12 × 8	10	49	6.99
044500	12 × 10	10	72	8.69
043114	14 × 6	10	57	6.94
043400	14 × 7	10	51	9.68
043800	14 × 8	10	57	7.35
044600	14 × 10	10	83	9.05
043900	16 × 8	10	64	8.42
044700	16 × 10	10	93	10.12
044000	18 × 8	10	104	10.30
044800	18 × 10	10	104	10.80
043120	20 × 6	10	109	9.99
044100	20 × 8	10	109	10.48
044900	20 × 10	10	135	11.69
044200	22 × 8	10	120	11.38
045000	22 × 10	10	148	12.63
044300	24 × 8	10	130	12.01
045100	24 × 10	10	160	12.95
046200	24 × 12	10	196	23.12
046400	24 × 14	10	226	28.00
044400	25 × 8	10	132	14.56
044448	25 × 9-1/2	10	200	20.59
044449	25 × 12	10	205	28.58
044447	26 × 9	10	200	20.59
044430	30 × 8	10	200	35.68
045400	30 × 10	10	270	44.65

- E.&O.E. - May not be in stock at all branches, if so please allow 10 days for delivery. -
 - All Prices F.O.B. Our Warehouse - Subject to Change Without Notice - All Taxes Extra -



CLEATS, DUCT, AND WALL STACKS

ECCO
Manufactured
Products

DUCT TAP-IN COLLARS (10" LONG)

STOCK #	SIZE (")	CTN/QTY	WT/100	PRICE/EA
050200	24 × 8	10	450	\$ 46.43
050100	25 × 8	10	460	50.71
050302	20 × 10	10	410	43.86
050301	22 × 10	10	430	49.06
050300	24 × 10	10	450	50.71
050250	25 × 9-1/2	10	472	50.71

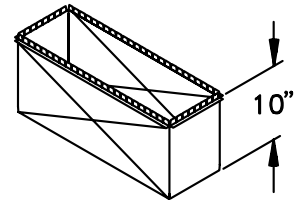

Duct Tap-In Collar
(10" Long)

DUCT TAP-IN COLLARS (4" LONG)

STOCK #	SIZE (")	CTN/QTY	WT/100	PRICE/EA
050308	8 × 8	10	116	\$ 24.82
050310	10 × 8	10	129	29.57
050312	12 × 8	10	143	33.91
050314	14 × 8	10	156	38.53
050316	16 × 8	10	169	43.19
050318	18 × 8	10	182	48.25
050320	20 × 8	10	195	52.55
050322	22 × 8	10	199	54.97
050324	24 × 8	10	220	61.15

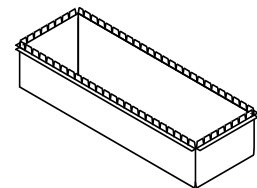

Duct Tap-In Collar
(4" Long)

DUCT TAP-IN COLLARS (4" × 10")

STOCK #	SIZE (")	CTN/QTY	WT/100	PRICE/EA
105802	4 × 10 – 8" long	20	110	\$ 21.46
105803	4 × 10 – 9-1/2" long	20	131	21.46
105805	4 × 10 – 11" long	20	151	21.46

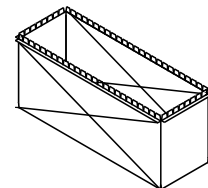

Duct Tap-In Collar
(4" × 10")

– E.&O.E. – May not be in stock at all branches, if so please allow 10 days for delivery. –
– All Prices F.O.B. Our Warehouse – Subject to Change Without Notice – All Taxes Extra –



CLEATS, DUCT, AND WALL STACKS

ECCO
Manufactured
Products

RETURN AIR SHOE

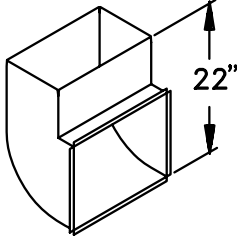

Return Air Shoe

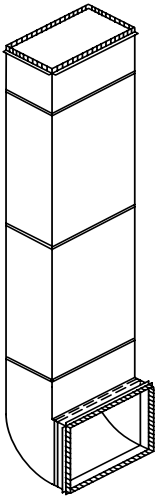

Return Air Drop Kit

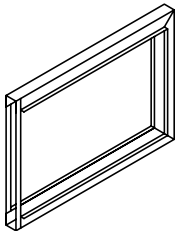

Filter Frame — Less Door

STOCK #	SIZE (")		CTN/QTY	PRICE/EA
050490	18 × 14	to 24 × 8	5	\$ 125.06
050494	19 × 19	to 20 × 10	5	153.12
050512	22 × 14	to 22 × 10	5	120.24
050510	22 × 14	to 24 × 8	5	120.24
050496	22-1/2 × 14-1/2	to 20 × 10	5	120.24
050518	22-1/2 × 14-1/2	to 24 × 10	5	122.09
050522	23 × 15	to 24 × 10	5	128.25
050504	23-1/2 × 15	to 18 × 10	5	114.35
050505	23-1/2 × 15	to 20 × 10	5	117.78
050506	23-1/2 × 15	to 22 × 10	5	121.23
050500	23-1/2 × 15	to 24 × 8	5	121.23
050507	23-1/2 × 15	to 24 × 10	5	124.66
050508	23-1/2 × 15	to 24 × 12	5	128.11
050502	23-1/2 × 18-1/2	to 24 × 8	5	127.25
050517	24 × 14	to 24 × 8	5	120.37
050520	24 × 14	to 24 × 10	5	123.80
050653	Return Air Frame		–	1.57/ft
050651	Return Air Frame 36" long (2-pc)		–	9.28

RETURN AIR DROP KIT

STOCK #	SIZE (")	CTN/QTY	PRICE/EA
050540	20 × 16 to 20 × 10 Drop Kit	1	\$ 325.74
050544	25 × 16 to 25 × 10 Drop Kit	1	393.70

Note: Each Return Air Drop Kit includes:

- 1 – Return Air Shoe c/w Filter Frame.
- 1 – Duct Tap-In Collar.
- 2 – Pieces of Drop Duct 28" Long.
- S-Cleats and Drive Cleats.

FILTER FRAMES — LESS DOOR

STOCK #	SIZE (")	CTN/QTY	PRICE/EA
599630	16 × 25 × 1	–	\$ 45.39
599631	16 × 25 × 3	–	62.99
599632	20 × 25 × 3	–	64.38

– E.&O.E. – May not be in stock at all branches, if so please allow 10 days for delivery. –
 – All Prices F.O.B. Our Warehouse – Subject to Change Without Notice – All Taxes Extra –



CLEATS, DUCT, AND WALL STACKS

ECCO
Manufactured
Products

FILTER FRAMES — WITH DOOR

STOCK #	SIZE (")	CTN/QTY	PRICE/EA
599627	16 × 20 × 1	–	\$ 49.37
599629	16 × 25 × 1	–	49.37
599633	16 × 25 × 3	–	71.55
599642	16-3/4 × 25 × 1	–	52.37
599628	20 × 20 × 1	–	49.37
599641	20 × 25 × 1	–	49.37
599634	20 × 25 × 3	–	72.76

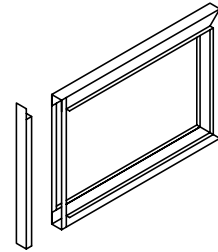

Filter Frame —
with Door

ELECTRONIC AIR CLEANER FILTER FRAMES

STOCK #	SIZE (")	DOOR SIZE	CTN/QTY	PRICE/EA
599635	16 × 25 × 6-3/4	1"	–	\$ 94.26
599637	16 × 25 × 6-3/4	4"	–	156.13
599636	20 × 25 × 6-3/4	1"	–	96.72
599638	20 × 25 × 6-3/4	4"	–	166.84

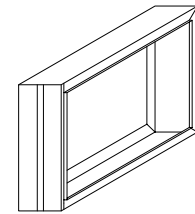

Electronic Air Cleaner
Filter Frame

DEDICATED ELECTRONIC AIR CLEANER FILTER FRAMES (HONEYWELL)

STOCK #	SIZE	DESCRIPTION	PRICE/EA
599643	16 × 20 × 7	Adjustable Filter Frame	\$ 136.86
599644	16 × 25 × 7	Adjustable Filter Frame	140.45
599645	20 × 20 × 7	Adjustable Filter Frame	139.51
599646	20 × 25 × 7	Adjustable Filter Frame	142.69

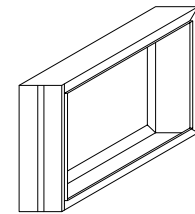

Electronic Air Cleaner
Filter Frame — Honeywell

DEDICATED ELECTRONIC AIR CLEANER FILTER FRAMES (WHITE RODGERS)

STOCK #	SIZE	DESCRIPTION	PRICE/EA
599663	16 × 20 × 7	Adjustable Filter Frame	\$ 155.90
599664	16 × 25 × 7	Adjustable Filter Frame	159.44
599665	20 × 20 × 7	Adjustable Filter Frame	158.55
599666	20 × 25 × 7	Adjustable Filter Frame	162.04

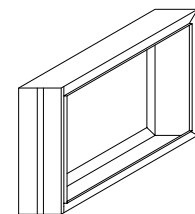

Electronic Air Cleaner
Filter Frame —
White Rodgers

– E.&O.E. – May not be in stock at all branches, if so please allow 10 days for delivery. –
– All Prices F.O.B. Our Warehouse – Subject to Change Without Notice – All Taxes Extra –



CLEATS, DUCT, AND WALL STACKS

ECCO
Manufactured
Products

CLEATS

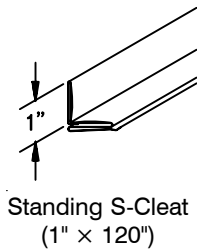
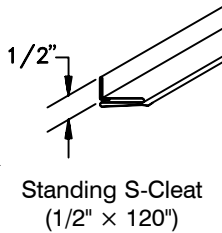
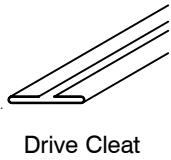
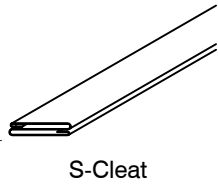

STOCK #	SIZE (")	GA	DESCRIPTION	PCS/BDL	WT/100 FT	PRICE/FT
052008	8	30	S-Cleat	10	12	P.O.A.
052010	10	30	S-Cleat	10	15	P.O.A.
052100	12	30	S-Cleat	10	18	P.O.A.
052200	14	30	S-Cleat	10	21	P.O.A.
052300	16	30	S-Cleat	10	24	P.O.A.
052400	18	30	S-Cleat	10	27	P.O.A.
052500	20	30	S-Cleat	10	30	P.O.A.
052600	22	30	S-Cleat	10	33	P.O.A.
052700	24	30	S-Cleat	10	36	P.O.A.
052910	60	Light GA	S-Cleat	10	13	\$ 0.85
052900	60	30	S-Cleat	10	18	1.43
052928	60	28	S-Cleat	10	24	1.62
052907	96	28	S-Cleat	10	24	1.84
052926	60	26	S-Cleat	10	28	2.02
053000	120	26	S-Cleat	10	28	2.02
053024	120	24	S-Cleat	10	36	2.24
053098	8	30	Drive Cleat	20	7	P.O.A.
053100	10	30	Drive Cleat	20	8	P.O.A.
053500	60	30	Drive Cleat	20	10	0.94
053508	96	30	Drive Cleat	20	10	1.03
053528	60	28	Drive Cleat	20	14	1.11
053507	96	28	Drive Cleat	20	14	1.11
053526	60	26	Drive Cleat	20	16	1.17
053600	120	26	Drive Cleat	20	16	1.17
053624	120	24	Drive Cleat	20	21	1.61
053622	120	22	Drive Cleat	20	26	2.17
580071	1/2 x 120	26	Standing S-Cleat	10	32	2.15
580073	1/2 x 120	24	Standing S-Cleat	10	40	2.45
580113	1 x 120	24	Standing S-Cleat	10	54	3.41
580115	1 x 120	22	Standing S-Cleat	10	69	4.48

Note: Standard sizes are in bold.

- E.&O.E. - May not be in stock at all branches, if so please allow 10 days for delivery. -
 - All Prices F.O.B. Our Warehouse - Subject to Change Without Notice - All Taxes Extra -



CLEATS, DUCT, AND WALL STACKS

ECCO
Manufactured
Products

DUCT HANGER STRAP

STOCK #	SIZE	GA	DESCRIPTION	PCS/BDL	WT/100 FT	PRICE/FT
580197	1"	22	Hanger Strap (10' long)	10	12	\$ 0.86
580200	1"	Light	Hanger Strap (10' long)	10	4	0.77
580201	1"	18	Hanger Strap (10' long)	10	18	1.12
580202	1"	18	Coil Duct Hanger	-	100	5.11/lb.

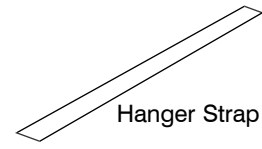

Hanger Strap

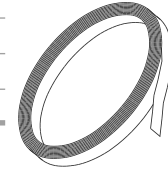

Coil
Duct Hanger

FIRE DAMPER ANGLE

STOCK #	SIZE (FT)	GA	DESCRIPTION	PCS/BDL	WT/100 FT	PRICE/FT
580211	8	30	2" x 2" Angle	-	22	\$ 2.96
580205	10	16	1-1/2" x 1-1/2" Angle	-	66	3.61

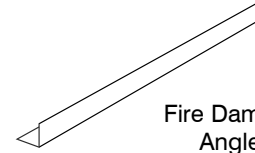

Fire Damper
Angle

WALL STACK 10" — RECTANGULAR

STOCK #	SIZE (")	LENGTH/FT	PCS/BDL	WT/100 FT	PRICE/FT
102730	3-1/4 x 10	3	45	152	\$ 9.81
102735	3-1/4 x 10	5	75	152	9.81
102738	3-1/4 x 10	8	120	152	9.81

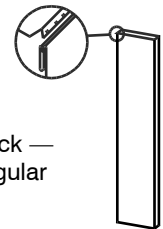

Wall Stack —
Rectangular

WALL STACK END CAPS

STOCK #	SIZE (")	PCS/BDL	WT/100	PRICE/EA
103100	3-1/4 x 10	10	21	\$ 5.37

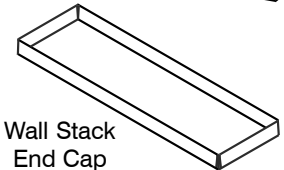

Wall Stack
End Cap

WALL STACK ELBOWS LONG WAY 90° (unassembled)

STOCK #	SIZE (")	CTN/QTY	WT/100	PRICE/EA
103500	3-1/4 x 10	10	210	\$ 45.88

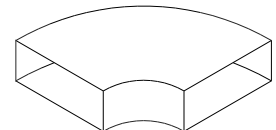

Wall Stack Elbow
Long Way 90°

WALL STACK ELBOWS SHORT WAY 90° (assembled)

STOCK #	SIZE (")	CTN/QTY	WT/100	PRICE/EA
103700	3-1/4 x 10	10	100	\$ 23.69

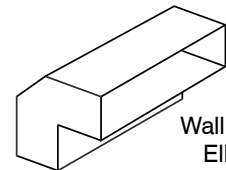

Wall Stack
Elbow
Short Way 90°

RANGE HOOD TRANSITIONS (ADAPTERS)

STOCK #	SIZE (")	CTN/QTY	WT/100	PRICE/EA
138400	4 – 3-1/4 x 10	40	70	\$ 12.33
138500	5 – 3-1/4 x 10	50	75	12.76
138600	6 – 3-1/4 x 10	30	90	16.28
138700	7 – 3-1/4 x 10	30	100	20.48
138750	8 – 3-1/4 x 10	20	115	31.10

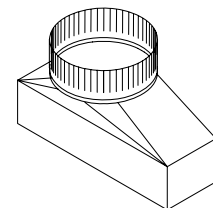

Range Hood Transition
(Adapter)

- E.&O.E. - May not be in stock at all branches, if so please allow 10 days for delivery. -
- All Prices F.O.B. Our Warehouse - Subject to Change Without Notice - All Taxes Extra -



CLEATS, DUCT, AND WALL STACKS

WALL STACK — OVAL

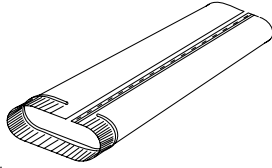

Wall Stack — Oval

STOCK #	SIZE (")	FT/BDL	WT/100	PRICE
111852	5 – (3 × 6-1/8) × 52	–	338	\$ 23.78/length
111652	6 – (3 × 7-3/4) × 52	–	399	25.87/length
111662	6 – (3 × 7-3/4) × 102	–	782	42.58/length
111663	6 – (3 × 7-3/4) × 104	–	836	43.31/length
111664	6 – (3 × 7-3/4) × 114	–	873	47.39/length
111660	6 – (3 × 7-3/4) × 96	40	92	5.61/ft
111670	7 – (3 × 9-1/4) × 96	40	106	8.98/ft
111680	8 – (3 × 10-7/8) × 96	40	119	9.85/ft

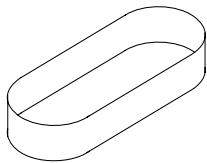

Oval End Cap

OVAL END CAP

STOCK #	SIZE (")	CTN/QTY	WT/100	PRICE/EA
111806	6 – (3 × 7-3/4)	20	20	\$ 23.65
111807	7 – (3 × 9-1/4)	20	25	24.73
111808	8 – (3 × 10-7/8)	20	30	25.94

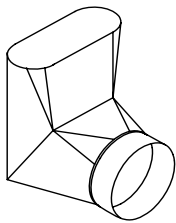

Round to Oval
Angle Boot 90°

ROUND TO OVAL ANGLE BOOT 90°

STOCK #	MODEL	SIZE (")	CTN/QTY	WT/100	PRICE/EA
097550	–	5 to 5 – (3 × 6-1/8)	20	90	\$ 28.13
097500	–	5 to 6 – (3 × 7-3/4)	30	90	24.38
097602	–	6 to 6	30	130	18.77
097600	GV2098	6 to 6 – (3 × 7-3/4)	16	130	26.77
097607	–	6 to 7 – (3 × 9-1/4)	12	135	26.88
097700	GV2099	7 to 7 – (3 × 9-1/4)	12	150	39.78
097800	–	8 to 8 – (3 × 10-7/8)	10	170	42.69

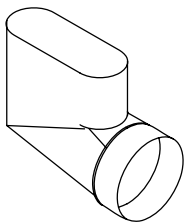

Round to Oval
End Boot 90°

ROUND TO OVAL END BOOT 90°

STOCK #	SIZE (")	CTN/QTY	WT/100	PRICE/EA
098500	5 to 6 – (3 × 7-3/4)	20	80	\$ 31.05
098600	6 to 6 – (3 × 7-3/4)	20	80	31.54
098607	6 to 7 – (3 × 9-1/4)	10	90	31.54
098700	7 to 7 – (3 × 9-1/4)	10	100	42.47
098800	8 to 8 – (3 × 10-7/8)	10	110	43.77

– E.&O.E. – May not be in stock at all branches, if so please allow 10 days for delivery. –
– All Prices F.O.B. Our Warehouse – Subject to Change Without Notice – All Taxes Extra –



CLEATS, DUCT, AND WALL STACKS

ECCO
Manufactured
Products

ROUND TO OVAL STRAIGHT BOOT

STOCK #	SIZE (")	CTN/QTY	WT/100	PRICE/EA
099500	5 to 6 – (3 × 7-3/4)	20	80	\$ 31.54
099600	6 to 6 – (3 × 7-3/4)	20	80	33.02
099700	7 to 7 – (3 × 9-1/4)	10	100	40.90
099800	8 to 8 – (3 × 10-7/8)	10	110	43.14
099607	6 to 7 – (3 × 9-1/4)	20	90	22.67



Round to Oval
Straight Boot

OVAL ELBOWS LONG WAY 90°

STOCK #	MODEL	SIZE (")	CTN/QTY	WT/100	PRICE/EA
111936	GV2062	6 (3 × 7-3/4)	40	130	\$ 22.67

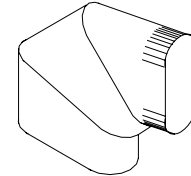

Oval Elbow
Long Way 90°

OVAL ELBOWS LONG WAY 45°

STOCK #	MODEL	SIZE (")	CTN/QTY	WT/100	PRICE/EA
111946	GV2059	6 (3 × 7-3/4)	25	70	\$ 49.46
111947	GV2060	7 (3 × 9-1/4)	15	90	53.22
111948	–	8 (3 × 10-7/8)	20	110	55.96

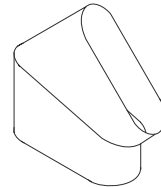

Oval Elbow
Long Way 45°

OVAL ELBOWS SHORT WAY 90°

STOCK #	MODEL	SIZE (")	CTN/QTY	WT/100	PRICE/EA
111939	GV2078	6 (3 × 7-3/4)	30	130	\$ 14.96
111942	GV2079	7 (3 × 9-1/4)	20	135	13.98

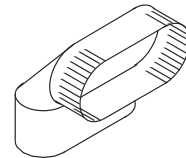

Oval Elbow
Short Way 90°

OVAL ELBOWS SHORT WAY 45°

STOCK #	MODEL	SIZE (")	CTN/QTY	WT/100	PRICE/EA
111966	GV2075	6 (3 × 7-3/4)	36	70	\$ 16.76
111967	GV2076	7 (3 × 9-1/4)	24	75	15.59

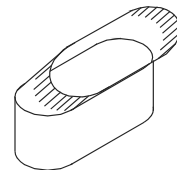

Oval Elbow
Short Way 45°

– E.&O.E. – May not be in stock at all branches, if so please allow 10 days for delivery. –
– All Prices F.O.B. Our Warehouse – Subject to Change Without Notice – All Taxes Extra –



CLEATS, DUCT, AND WALL STACKS

ECCO
Manufactured
Products

RESIDENTIAL DUCT FITTINGS

<p>OPEN END JOINT? PLENUM</p>	<p>PLENUM OFFSET</p>	<p>PLENUM ELBOW</p>	<p>SPLIT PLENUM</p>
<p>PLENUM TAKE-OFF</p>	<p>TRANSITION PLENUM TAKE-OFF</p>	<p>PLENUM TAKE-OFF ELBOW</p>	<p>LONG WAY</p>
<p>PLENUM TAKE-OFF FLAT</p>	<p>LOOKING INTO PLENUM END, SPECIFY WHEN ORDERING:</p> <ul style="list-style-type: none"> - LEFT FLAT - RIGHT FLAT - ON CENTER - 4" RISE - TOP FLAT 	<p>LOOKING INTO PLENUM END, SPECIFY WHEN ORDERING:</p> <ul style="list-style-type: none"> - LEFT OUT - RIGHT OUT - TOP FLAT - THROAT LENGTH 	<p>SHORT WAY</p>
<p>DUCT TEE</p>	<p>RETURN AIR SHOE</p>	<p>DUCT RISER</p>	
<p>DUCT REDUCER</p>	<p>LOOKING INTO THE "LARGE" END, SPECIFY WHEN ORDERING:</p> <ul style="list-style-type: none"> - LEFT FLAT - RIGHT FLAT - ON CENTER - TOP FLAT - BOTTOM FLAT <p>TU=TOP UP TD=TOP DOWN</p>	<p>DUCT OFFSET</p>	

- E.&O.E. - May not be in stock at all branches, if so please allow 10 days for delivery. -
 - All Prices F.O.B. Our Warehouse - Subject to Change Without Notice - All Taxes Extra -