

REPLACEMENT BLOWER PARTS AND DRIVES

INDEX

| | |
|---|------------|
| ACCESSORIES..... | 12-7 |
| ADJUSTABLE MOTOR PULLEYS | |
| ALUMINUM..... | 12-3 |
| CAST IRON..... | 12-2 |
| BEARINGS..... | 12-6 –12-7 |
| BELTS | |
| TYPE 4L..... | 12-3 |
| TYPE A..... | 12-4 –12-5 |
| TYPE B..... | 12-5 –12-6 |
| BLOWER PULLEYS — CAST ALUMINUM..... | 12-2 |
| REPLACEMENT SHAFTS..... | 12-6 |
| REPLACEMENT WHEELS | |
| FOR BELT DRIVE BLOWERS..... | 12-7 |
| FOR DIRECT DRIVE BLOWERS..... | 12-7 |
| VOLUME PRESSURE BLOWERS — DIRECT DRIVE — WITH CLOCKWISE ROTATION..... | 12-2 |
| TECHNICAL DATA..... | 12-8 |

ECCO is proud to be a member of:



ASHRAE
American Society of
Heating, Refrigerating, and
Air-Conditioning Engineers, Inc.
www.ashrae.org



HRAI
Heating, Refrigeration
and Air Conditioning
Institute of Canada
www.hrai.ca



HARDI
Heating, Airconditioning &
Refrigeration Distributors
International
www.hardinet.org



SMACNA
Sheet Metal and Air
Conditioning Contractors'
National Association
www.smacna.org



SPIDA
Spiral Duct
Manufacturers
Association
www.spida.org

REPLACEMENT BLOWER PARTS AND DRIVES

VOLUME PRESSURE BLOWERS — DIRECT DRIVE — WITH CLOCKWISE ROTATION

| STOCK # | MODEL | DESCRIPTION | RECOMMENDED MOTOR HP | PRICE |
|---------|------------|----------------|----------------------|----------|
| 810170 | PW8-2C940 | 125 – 295 CFM | 1/3 | \$876.04 |
| 810174 | PW12-4C329 | 410 – 1190 CFM | 3 | 1,425.00 |



NOTE: Motors not included in above prices — P.O.A.
For Technical Data, see end of section.

BLOWER PULLEYS — CAST ALUMINUM

| STOCK # | SIZE (") | DESCRIPTION | WEIGHT (LBS) | PRICE |
|---------|----------|---------------|--------------|---------|
| 810130 | 5 × 3/4 | Cast Aluminum | 1 | \$24.00 |
| 810131 | 6 × 3/4 | Cast Aluminum | 1 | 28.00 |
| 810132 | 7 × 3/4 | Cast Aluminum | 1.5 | 36.00 |
| 810133 | 8 × 3/4 | Cast Aluminum | 1.5 | 41.00 |
| 810134 | 9 × 3/4 | Cast Aluminum | 2 | 44.00 |
| 810135 | 10 × 3/4 | Cast Aluminum | 2 | 52.00 |
| 810139 | 8 × 1 | Cast Aluminum | 1.5 | 42.00 |
| 810141 | 10 × 1 | Cast Aluminum | 2 | 52.00 |

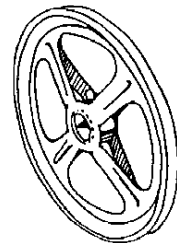

ADJUSTABLE MOTOR PULLEYS — CAST IRON

| STOCK # | DESCRIPTION | OUTSIDE DIAMETER (") | WEIGHT (LBS) | PRICE |
|---------|-----------------------------|----------------------|--------------|---------|
| 810160 | IVL25 × 1/2" / MVL25 × 1/2" | 2.5 | 1 | \$24.00 |
| 810161 | IVL25 × 5/8" / MVL25 × 5/8" | 2.5 | 1 | 24.00 |
| 810162 | IVL30 × 1/2" / MVL30 × 1/2" | 2.87 | 1 | 26.00 |
| 810149 | IVL30 × 5/8" / MVL30 × 5/8" | 2.87 | 1 | 26.00 |
| 810152 | IVL34 × 1/2" / MVL34 × 1/2" | 3.15 | 1.1 | 32.00 |
| 810153 | IVL34 × 5/8" / MVL34 × 5/8" | 3.15 | 1.1 | 32.00 |
| 810157 | IVL40 × 1/2" / MVL40 × 1/2" | 3.75 | 1.4 | 38.00 |
| 810156 | IVL40 × 5/8" / MVL40 × 5/8" | 3.75 | 1.4 | 38.00 |
| 810158 | IVL40 × 7/8" / MVL40 × 7/8" | 3.75 | 1.4 | 41.00 |
| 810154 | IVL44 × 1/2" / MVL44 × 1/2" | 4.15 | 1.6 | 46.00 |
| 810155 | IVL44 × 5/8" / MVL44 × 5/8" | 4.15 | 1.6 | 48.00 |
| 810163 | IVL44 × 7/8" / MVL44 × 7/8" | 4.15 | 1.6 | 48.00 |

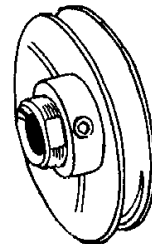

– E.&O.E. – May not be in stock at all branches, if so please allow 10 days for delivery. –
– All Prices F.O.B. Our Warehouse – Subject to Change Without Notice – All Taxes Extra –

REPLACEMENT BLOWER PARTS AND DRIVES

ADJUSTABLE MOTOR PULLEYS — ALUMINUM

| STOCK # | SIZE (") | WEIGHT (LBS) | PRICE |
|---------|-------------|--------------|---------|
| 810150 | 3-1/4 × 1/2 | 1 | \$37.00 |
| 810151 | 3-1/4 × 5/8 | 1 | 44.00 |
| 810147 | 3-1/2 × 1/2 | 1.2 | 37.00 |
| 810148 | 3-1/2 × 5/8 | 1.3 | 37.00 |



TYPE 4L BELTS

| STOCK # | MODEL | DESCRIPTION | SIZE (") | PRICE |
|---------|-------|-------------|----------|--------|
| 812142 | 4L190 | V Belt | 19 | \$9.00 |
| 812143 | 4L200 | V Belt | 20 | 9.00 |
| 812144 | 4L210 | V Belt | 21 | 9.00 |
| 812145 | 4L220 | V Belt | 22 | 9.00 |
| 812146 | 4L230 | V Belt | 23 | 9.00 |
| 812147 | 4L240 | V Belt | 24 | 9.00 |
| 812148 | 4L250 | V Belt | 25 | 9.00 |
| 812149 | 4L260 | V Belt | 26 | 9.00 |
| 812151 | 4L270 | V Belt | 27 | 9.00 |
| 812152 | 4L280 | V Belt | 28 | 9.00 |
| 812153 | 4L290 | V Belt | 29 | 9.00 |
| 812154 | 4L300 | V Belt | 30 | 9.00 |
| 812155 | 4L310 | V Belt | 31 | 9.00 |
| 812156 | 4L320 | V Belt | 32 | 9.00 |
| 812157 | 4L330 | V Belt | 33 | 9.00 |
| 812158 | 4L340 | V Belt | 34 | 9.00 |
| 812159 | 4L350 | V Belt | 35 | 9.00 |
| 812160 | 4L360 | V Belt | 36 | 9.00 |
| 812161 | 4L370 | V Belt | 37 | 9.00 |
| 812162 | 4L380 | V Belt | 38 | 10.00 |
| 812163 | 4L390 | V Belt | 39 | 10.00 |
| 812164 | 4L400 | V Belt | 40 | 10.00 |
| 812165 | 4L410 | V Belt | 41 | 10.00 |
| 812166 | 4L420 | V Belt | 42 | 11.00 |
| 812167 | 4L430 | V Belt | 43 | 11.00 |
| 812168 | 4L440 | V Belt | 44 | 11.00 |
| 812169 | 4L450 | V Belt | 45 | 11.00 |
| 812170 | 4L460 | V Belt | 46 | 11.00 |
| 812171 | 4L470 | V Belt | 47 | 11.00 |
| 812172 | 4L480 | V Belt | 48 | 11.00 |
| 812173 | 4L490 | V Belt | 49 | 11.00 |
| 812174 | 4L500 | V Belt | 50 | 12.00 |
| 812176 | 4L520 | V Belt | 52 | 13.00 |
| 812177 | 4L530 | V Belt | 53 | 13.00 |
| 812178 | 4L540 | V Belt | 54 | 13.00 |
| 812179 | 4L550 | V Belt | 55 | 13.00 |
| 812181 | 4L570 | V Belt | 57 | 14.00 |
| 812182 | 4L580 | V Belt | 58 | 14.00 |



– E.&O.E. – May not be in stock at all branches, if so please allow 10 days for delivery. –
 – All Prices F.O.B. Our Warehouse – Subject to Change Without Notice – All Taxes Extra –

REPLACEMENT BLOWER PARTS AND DRIVES

TYPE A BELTS

| STOCK # | MODEL | DESCRIPTION | SIZE (") | PRICE |
|---------|-------|-------------|----------|---------|
| 812238 | A18 | V Belt | 18 | \$10.00 |
| 812185 | A20 | V Belt | 20 | 12.00 |
| 812186 | A21 | V Belt | 21 | 13.00 |
| 812187 | A22 | V Belt | 22 | 13.00 |
| 812188 | A23 | V Belt | 23 | 14.00 |
| 812189 | A24 | V Belt | 24 | 14.00 |
| 812190 | A25 | V Belt | 25 | 14.00 |
| 812191 | A26 | V Belt | 26 | 14.00 |
| 812192 | A27 | V Belt | 27 | 14.00 |
| 812193 | A28 | V Belt | 28 | 15.00 |
| 812194 | A29 | V Belt | 29 | 15.00 |
| 812195 | A30 | V Belt | 30 | 15.00 |
| 812196 | A31 | V Belt | 31 | 15.00 |
| 812197 | A32 | V Belt | 32 | 15.00 |
| 812198 | A33 | V Belt | 33 | 15.00 |
| 812199 | A34 | V Belt | 34 | 16.00 |
| 812200 | A35 | V Belt | 35 | 16.00 |
| 812201 | A36 | V Belt | 36 | 16.00 |
| 812202 | A37 | V Belt | 37 | 16.00 |
| 812203 | A38 | V Belt | 38 | 16.00 |
| 812204 | A39 | V Belt | 39 | 16.00 |
| 812205 | A40 | V Belt | 40 | 17.00 |
| 812206 | A41 | V Belt | 41 | 18.00 |
| 812207 | A42 | V Belt | 42 | 18.00 |
| 812208 | A43 | V Belt | 43 | 18.00 |
| 812209 | A44 | V Belt | 44 | 18.00 |
| 812210 | A45 | V Belt | 45 | 18.00 |
| 812211 | A46 | V Belt | 46 | 19.00 |
| 812212 | A47 | V Belt | 47 | 20.00 |
| 812213 | A48 | V Belt | 48 | 20.00 |
| 812214 | A49 | V Belt | 49 | 20.00 |
| 812215 | A50 | V Belt | 50 | 20.00 |
| 812216 | A51 | V Belt | 51 | 20.00 |
| 812217 | A52 | V Belt | 52 | 20.00 |
| 812218 | A53 | V Belt | 53 | 22.00 |
| 812219 | A54 | V Belt | 54 | 22.00 |
| 812220 | A55 | V Belt | 55 | 24.00 |
| 812221 | A56 | V Belt | 56 | 24.00 |
| 812222 | A57 | V Belt | 57 | 24.00 |
| 812223 | A58 | V Belt | 58 | 24.00 |
| 812224 | A59 | V Belt | 59 | 24.00 |
| 812225 | A60 | V Belt | 60 | 25.00 |
| 812226 | A61 | V Belt | 61 | 25.00 |
| 812227 | A62 | V Belt | 62 | 25.00 |



(cont'd on next page)

- E.&O.E. - May not be in stock at all branches, if so please allow 10 days for delivery. -
 - All Prices F.O.B. Our Warehouse - Subject to Change Without Notice - All Taxes Extra -

REPLACEMENT BLOWER PARTS AND DRIVES

TYPE A BELTS (cont'd)

| STOCK # | MODEL | DESCRIPTION | SIZE (") | PRICE |
|---------|-------|-------------|----------|---------|
| 812229 | A64 | V Belt | 64 | \$25.00 |
| 812230 | A65 | V Belt | 65 | 25.00 |
| 812231 | A66 | V Belt | 66 | 32.00 |
| 812232 | A67 | V Belt | 67 | 32.00 |
| 812233 | A68 | V Belt | 68 | 32.00 |
| 812234 | A69 | V Belt | 69 | 34.00 |
| 812236 | A71 | V Belt | 71 | 35.00 |
| 812237 | A72 | V Belt | 72 | 35.00 |



TYPE B BELTS

| STOCK # | MODEL | DESCRIPTION | SIZE (") | PRICE |
|---------|-------|-------------|----------|---------|
| 812246 | B26 | V Belt | 26 | \$16.00 |
| 812248 | B28 | V Belt | 28 | 18.00 |
| 812249 | B29 | V Belt | 29 | 18.00 |
| 812250 | B30 | V Belt | 30 | 19.00 |
| 812251 | B31 | V Belt | 31 | 19.00 |
| 812252 | B32 | V Belt | 32 | 20.00 |
| 812253 | B33 | V Belt | 33 | 20.00 |
| 812254 | B34 | V Belt | 34 | 21.00 |
| 812255 | B35 | V Belt | 35 | 21.00 |
| 812256 | B36 | V Belt | 36 | 22.00 |
| 812257 | B37 | V Belt | 37 | 23.00 |
| 812258 | B38 | V Belt | 38 | 25.00 |
| 812259 | B39 | V Belt | 39 | 25.00 |
| 812260 | B40 | V Belt | 40 | 25.00 |
| 812261 | B41 | V Belt | 41 | 25.00 |
| 812262 | B42 | V Belt | 42 | 26.00 |
| 812263 | B43 | V Belt | 43 | 26.00 |
| 812264 | B44 | V Belt | 44 | 26.00 |
| 812265 | B45 | V Belt | 45 | 27.00 |
| 812266 | B46 | V Belt | 46 | 27.00 |
| 812267 | B47 | V Belt | 47 | 29.00 |
| 812268 | B48 | V Belt | 48 | 29.00 |
| 812269 | B49 | V Belt | 49 | 29.00 |
| 812270 | B50 | V Belt | 50 | 29.00 |
| 812271 | B51 | V Belt | 51 | 30.00 |
| 812272 | B52 | V Belt | 52 | 30.00 |
| 812273 | B53 | V Belt | 53 | 30.00 |
| 812274 | B54 | V Belt | 54 | 30.00 |
| 812275 | B55 | V Belt | 55 | 31.00 |
| 812276 | B56 | V Belt | 56 | 31.00 |
| 812277 | B57 | V Belt | 57 | 31.00 |
| 812278 | B58 | V Belt | 58 | 32.00 |
| 812279 | B59 | V Belt | 59 | 32.00 |



(cont'd on next page)

- E.&O.E. - May not be in stock at all branches, if so please allow 10 days for delivery. -
 - All Prices F.O.B. Our Warehouse - Subject to Change Without Notice - All Taxes Extra -

REPLACEMENT BLOWER PARTS AND DRIVES

TYPE B BELTS (cont'd)

| STOCK # | MODEL | DESCRIPTION | SIZE (") | PRICE |
|---------|-------|-------------|----------|---------|
| 812280 | B60 | V Belt | 60 | \$32.00 |
| 812281 | B61 | V Belt | 61 | 32.00 |
| 812282 | B62 | V Belt | 62 | 32.00 |
| 812283 | B63 | V Belt | 63 | 32.00 |
| 812284 | B64 | V Belt | 64 | 33.00 |
| 812285 | B65 | V Belt | 65 | 33.00 |
| 812286 | B66 | V Belt | 66 | 33.00 |
| 812287 | B67 | V Belt | 67 | 34.00 |
| 812288 | B68 | V Belt | 68 | 34.00 |
| 812289 | B69 | V Belt | 69 | 35.00 |
| 812290 | B70 | V Belt | 70 | 35.00 |
| 812291 | B71 | V Belt | 71 | 35.00 |
| 812292 | B72 | V Belt | 72 | 35.00 |
| 812293 | B73 | V Belt | 73 | 36.00 |
| 812294 | B74 | V Belt | 74 | 36.00 |
| 812295 | B75 | V Belt | 75 | 36.00 |
| 812296 | B76 | V Belt | 76 | 36.00 |
| 812297 | B77 | V Belt | 77 | 38.00 |
| 812299 | B79 | V Belt | 79 | 41.00 |
| 812300 | B80 | V Belt | 80 | 41.00 |
| 812302 | B82 | V Belt | 82 | 41.00 |
| 812303 | B83 | V Belt | 83 | 41.00 |



REPLACEMENT SHAFTS

| STOCK # | MODEL | DESCRIPTION | PRICE |
|---------|----------|----------------|---------|
| 810352 | 67-61110 | 3/4" x 11-5/8" | \$20.00 |
| 810354 | 67-61400 | 3/4" x 14" | 32.00 |
| 810356 | 67-61600 | 3/4" x 16" | 35.00 |
| 810358 | 67-61800 | 3/4" x 18" | 43.00 |
| 810360 | 67-62000 | 3/4" x 20" | 48.00 |
| 810362 | 67-62200 | 3/4" x 22" | 50.00 |
| 810364 | 67-62400 | 3/4" x 24" | 50.00 |
| 810370 | 67-82400 | 1" x 24" | 50.00 |



BEARINGS

| STOCK # | DESCRIPTION | SIZE (") | QTY/PACK | PRICE/PR |
|---------|------------------------|----------|----------|----------|
| 810230 | Pillow Block Bearings | 3/4 | 2 | \$79.00 |
| C810100 | Pillow Block Bearings | 1 | 2 | P.O.A. |
| 810233 | Sealed Sleeve Bearings | 3/4 | 2 | 40.00 |
| 810234 | Sealed Sleeve Bearings | 1 | 2 | 40.00 |
| 810235 | Ball Bearings | 3/4 | 2 | 65.00 |
| 810236 | Ball Bearings | 1 | 2 | 110.00 |

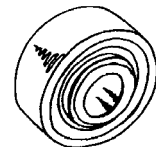
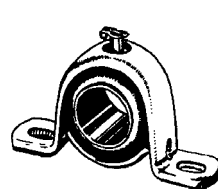

Pillow Block Bearing

– E.&O.E. – May not be in stock at all branches, if so please allow 10 days for delivery. –
 – All Prices F.O.B. Our Warehouse – Subject to Change Without Notice – All Taxes Extra –

REPLACEMENT BLOWER PARTS AND DRIVES

BEARINGS — MISCELLANEOUS

| STOCK # | MODEL | DESCRIPTION | PRICE/PR |
|---------|-----------|----------------------------|----------|
| 810320 | 67-4138-2 | 3/4" Torin Sleeve Bearings | \$27.00 |
| 810322 | 67-4136-2 | 3/4" Delhi Sleeve Bearings | 28.50 |
| 810319 | 67-4137-2 | 3/4" Lau Sleeve Bearings | 27.00 |



Ball Bearing

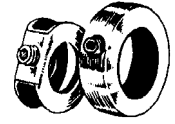

Bearing

ACCESSORIES

| STOCK # | DESCRIPTION | SIZE (") | QTY/PACK | PRICE |
|---------|-----------------------------|----------|----------|------------|
| 810241 | Thrust Collar Kit | 3/4 | 2 | \$19.00/pr |
| 810242 | Thrust Collar Kit | 1 | 2 | 22.00/pr |
| 810243 | Thrust Spacers | 3/4 | 2 | 4.00/pr |
| 810245 | Vibro Pad Isolation Grommet | - | 1 | 2.50/ea |
| 810246 | Motor Mtg. Hardware Kit | - | 1 | 18.00/ea |
| 810247 | Grommet for Motor Leg | - | 1 | 3.50/ea |

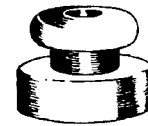

Vibro Pad

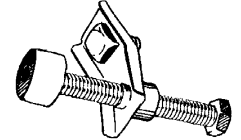
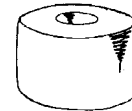
 Motor Mtg.
Hardware Kit

Grommet

REPLACEMENT WHEELS (FOR BELT DRIVE BLOWERS)

| STOCK # | MODEL | SHAFT SIZE (") | WEIGHT (LBS) | PRICE |
|---------|-----------|----------------|--------------|----------|
| C810100 | A9 - 6A | 3/4 | 7 | P.O.A. |
| C810100 | A9 - 7A | 3/4 | 7 | P.O.A. |
| 810101 | A9 - 9A | 3/4 | 8 | \$100.00 |
| C810100 | A9 - 10A | 3/4 | 8 | P.O.A. |
| C810100 | A10 - 6A | 3/4 | 7 | P.O.A. |
| 810107 | A10 - 7A | 3/4 | 7 | 120.00 |
| 810102 | A10 - 8A | 3/4 | 7 | 120.00 |
| 810103 | A10 - 10A | 3/4 | 9 | 120.00 |
| 810105 | A12 - 12A | 3/4 | 14 | 172.00 |
| C810100 | A15 - 15A | 1 | 20 | P.O.A. |

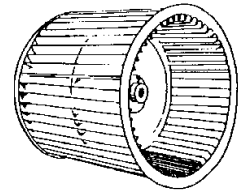

REPLACEMENT WHEELS (FOR DIRECT DRIVE BLOWERS)

| STOCK # | MODEL | SHAFT SIZE (") | WEIGHT (LBS) | PRICE |
|---------|---------|----------------|--------------|---------|
| C810100 | DD9-4 | 1/2 | 6 | P.O.A. |
| C810100 | DD9-6 | 1/2 | 6 | P.O.A. |
| 810112 | DD9-7 | 1/2 | 6 | \$90.00 |
| 810113 | DD9-9 | 1/2 | 7 | 90.00 |
| C810100 | DD10-8 | 1/2 | 7 | P.O.A. |
| C810100 | DD10-9 | 1/2 | 8 | P.O.A. |
| 810115 | DD10-10 | 1/2 | 9 | 120.00 |

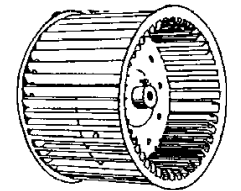

- E.&O.E. - May not be in stock at all branches, if so please allow 10 days for delivery. -
 - All Prices F.O.B. Our Warehouse - Subject to Change Without Notice - All Taxes Extra -

REPLACEMENT BLOWER PARTS AND DRIVES

TECHNICAL DATA

VOLUME PRESSURE BLOWERS — DIRECT DRIVE — WITH CLOCKWISE ROTATION

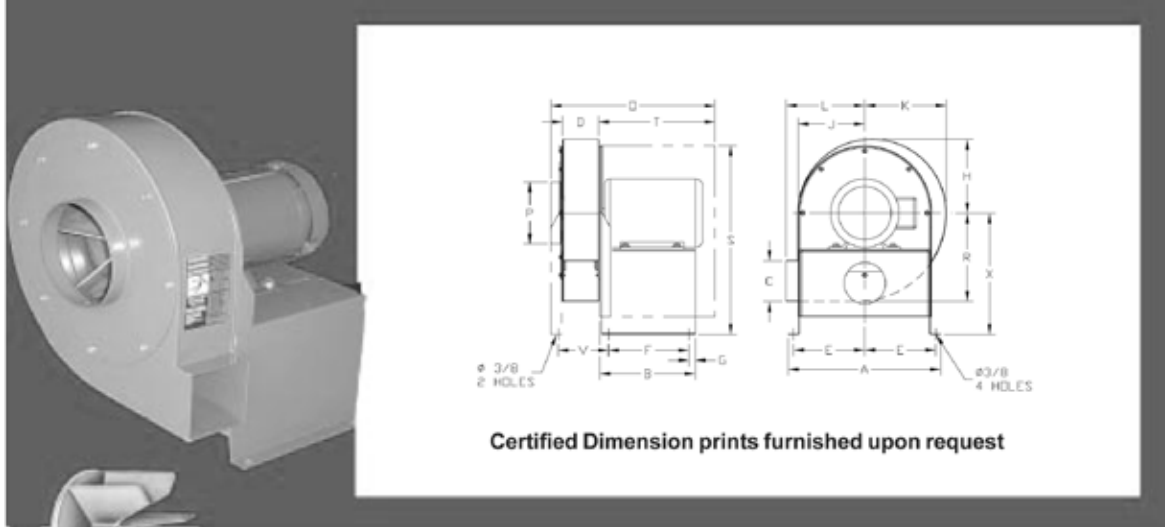

PRESSURE BLOWERS Direct Drive

Application:

Pressure blowers are generally used on industrial applications for small exhaust systems where air is laden with dust or grit and also for supplying high pressure air for conveying and cooling.

Features:

Wheels – Constructed with straight radial blades of heavy cast aluminum for self cleaning feature, dynamically balanced and designed for efficient operation.

Housings – Arc-welded 16 gauge steel housings and motor bases for rigidity and long life.

Motors – Standard units are furnished with open ball bearing, rigid mounted motors of either single phase capacitor-induction type or three phase induction type. Motors can also be furnished totally enclosed or explosion proof or with special current characteristics for special applications.

Rotation and Discharge – Furnished for clockwise rotation, bottom horizontal discharge unless otherwise specified. At time of installation housings or wheels may be turned for other discharges and rotation if so desired.

Capacities – Tested in accordance with AMCA Standards 210.

Blower Performance

| MODEL NO. | MOTOR H.P. | BLOWER RPM | PERFORMANCE - C.F.M. | | | | | | | | | | | | | | | | | |
|-----------|------------|------------|----------------------|-----------|---------|-------------|---------|-------------|---------|-------------|---------|---------|---------|---------|---------|---------|----------|----------|----------|-----|
| | | | 1/4" S.P. | 1/2" S.P. | 1" S.P. | 1-1/2" S.P. | 2" S.P. | 2-1/2" S.P. | 3" S.P. | 3-1/2" S.P. | 4" S.P. | 5" S.P. | 6" S.P. | 7" S.P. | 8" S.P. | 9" S.P. | 10" S.P. | 11" S.P. | 12" S.P. | |
| PW-8 | 1/4 | 3500 | - | - | - | 237 | 216 | 192 | 165 | 129 | 70 | - | - | - | - | - | - | - | - | - |
| PW-8 | 1/3 | 3500 | 283 | 274 | 256 | 237 | 216 | 192 | 165 | 129 | 70 | - | - | - | - | - | - | - | - | - |
| PW-9 | 1/2 | 3500 | - | - | - | - | - | 374 | 346 | 316 | 282 | 195 | - | - | - | - | - | - | - | - |
| PW-9 | 3/4 | 3500 | 475 | 465 | 445 | 423 | 399 | 374 | 346 | 316 | 282 | 195 | - | - | - | - | - | - | - | - |
| PW-11 | 1 | 3500 | - | - | - | - | - | - | - | - | - | - | 508 | 431 | 329 | - | - | - | - | - |
| PW-11 | 1-1/2 | 3500 | 786 | 772 | 746 | 719 | 692 | 664 | 635 | 606 | 575 | 508 | 431 | 329 | - | - | - | - | - | - |
| PW-12 | 3 | 3500 | 1185 | 1171 | 1145 | 1117 | 1090 | 1062 | 1033 | 1004 | 974 | 911 | 842 | 765 | 672 | 549 | - | - | - | - |
| PW-14 | 5 | 3500 | - | - | - | - | - | - | - | - | - | - | 1685 | 1587 | 1482 | 1367 | 1236 | 1081 | 874 | 474 |
| PW-14 | 7-1/2 | 3500 | 2100 | 2079 | 2037 | 1995 | 1952 | 1909 | 1866 | 1822 | 1777 | 1685 | 1587 | 1482 | 1367 | 1236 | 1081 | 874 | 474 | - |

Blower Dimensions

| BLOWER | WHEEL | BORE | A | B | C | D | E | F | G | H | J | K | L | O | P | R | X | S | T | V |
|--------|----------------|-------|--------|--------|-------|-------|-------|--------|-----|--------|-------|--------|-------|--------|---|--------|--------|--------|----|-------|
| PW-8 | 7-3/4 X 2-1/4 | 1/2 | 11 | 8 | 3 | 3 | 5 | 7 | 1/2 | 5-3/8 | 4-7/8 | 5-7/8 | 5-7/8 | 16 | 4 | 6-5/8 | 8-1/2 | 13-1/8 | 12 | ... |
| PW-9 | 9 X 2-3/4 | 1/2 | 12-1/8 | 8 | 3-1/2 | 3-1/2 | 5-5/8 | 7 | 1/2 | 6-3/8 | 5-3/4 | 6-7/8 | 6-3/4 | 20-3/4 | 5 | 7-1/2 | 9-3/8 | 14-5/8 | 16 | ... |
| PW-11 | 10-5/8 X 3 | 5/8 | 14-3/4 | 9 | 4 | 3-1/2 | 6-7/8 | 7-1/2 | 3/4 | 7-1/4 | 6-1/2 | 8 | 7-5/8 | 20-3/4 | 6 | 8-5/8 | 11-3/4 | 18-1/4 | 16 | ... |
| PW-12 | 12-1/2 X 3 | 7/8 | 17 | 8 | 5 | 4 | 8 | 6-1/2 | 3/4 | 8-1/4 | 7-1/2 | 9 | 9-5/8 | 20-1/8 | 7 | 10 | 10-5/8 | 18-3/8 | 15 | ... |
| PW-14 | 13-1/2 X 4-3/8 | 1-1/8 | 17-5/8 | 11-1/4 | 7-1/8 | 5-3/4 | 8 | 9-9/16 | 1 | 10-1/2 | 9-5/8 | 11-3/8 | 11 | 22 | 8 | 11-1/2 | 12-5/8 | 21-1/2 | 15 | 7-1/4 |

- E.&O.E. - May not be in stock at all branches, if so please allow 10 days for delivery. -
- All Prices F.O.B. Our Warehouse - Subject to Change Without Notice - All Taxes Extra -